

# Information Reliability in Smart Grid Scenario over Imperfect Communication Networks using IEC-61850 MMS

Rafia Umair, Kamal Shahid, Rasmus L. Olsen

Department of Electronic Systems, Aalborg University, Denmark

Email: rafi@techcollege.dk, ksh@es.aau.dk, rlo@es.aau.dk

**Abstract**—The trend of producing energy from Renewable Generation (ReGen) plants is greatly increasing. This leads to the objective of building future power generation system entirely based on renewable sources. Since the power output of ReGen plants, such as wind power plants (WPP), varies continuously and thereby the voltages in the distribution grid, an effective control system is required, to govern the production from all ReGen plants. For this, control messages must be exchanged between the grid assets with reliable information to achieve optimum efficiency. This raises a challenge to assess information reliability and evaluate the performance of a controller. Therefore, considering the dynamic nature of information, this paper analyzes the information reliability in terms of correct and timely delivery of message signals, for remote control of a WPP using IEC-61850 MMS in a smart grid scenario. Based on this measure, the quality of controller performance is also calculated over various imperfect network conditions.

**Keywords**—Renewable Generation (ReGen) Plants; IEC-61850; Manufacture Message Specification (MMS); Communication

## I. INTRODUCTION

Power generation in past was mainly based on big centralized power stations such as nuclear power plant, fossil fuel, gas, coal fired and hydroelectric dams. However, with advancements in technology and the aim of protecting the environment, Distributed Energy Resources (DER) based on Renewable Generation (ReGen) plants are taking over worldwide, especially in Europe, Canada, USA and Japan [1]. For instance, with the addition of ReGen plants into the power grid, Danish parliament aims a 50% reduction of fossil fuels for the production of electricity and heat by 2020 [2], while a 100% renewable energy based power system by the end of 2050.

DER is different from centralized power generation in that it is distributed and easy to install. It produces electricity in an environmental friendly, secure, sustainable and reliable manner. However, the biggest challenge of a DER network is to monitor and control its operations. For control and management of DER, the concept of microgrid was introduced. Microgrid is a small scale power system comprising of DER, Distributed Energy Storage (DES) and controllable loads. The purpose of a microgrid is to self-maintain DER in conjunction with transmission, distribution and storage of electricity. It also

seamlessly has a synchronized connection to a utility power, and can also operate as an independent power system [3].

In order to realize the objectives of DER, microgrid requires a control system to actively balance between energy production and consumption. The microgrid control system has a hierarchical control structure consisting of a medium voltage grid controller (MVGC), and a low voltage grid controller (LVGC) employed for controlling the medium voltage (MV) grid and low voltage (LV) grid respectively [4]. The major requirement of a microgrid is an interconnection of its components to a control-center via a communication infrastructure, to support a variety of messages, such as real time monitoring, control, demand and response. All such communication messages have their own transfer time and reliability requirements, which must be satisfied for a reliable operation. Therefore, analysis of network performance, in terms of reliability, is of critical importance in a DER network.

The transport layer protocol, TCP guarantees a reliable exchange of information between the two end devices, but at the cost of higher end-to-end delays (depending on the network conditions). Since TCP was not designed considering the requirements of data for smart grids, the reliability it offers may not be beneficial for many of its applications where timely reception/transmission of data is much more important than delivery at any cost. Therefore, it is highly important to analyze as to which transport layer protocol (TCP or UDP) provides higher reliability in terms of timely delivery of information. In this paper, the timely delivery of information is determined by measuring the level of match of information between sender and receiver. The reason for this measure is that a mismatch of information between the ReGen plant and the controller, may potentially lead to the degradation of the control performance, affecting the overall stability of the power system. Based on the same measure, the quality of controller performance has also been measured under different network conditions.

Several standards have been proposed related to the communication aspects in electric power systems, especially microgrid. Since IEC-61850 is becoming the de-facto for the communication between DER and control center, it has been implemented in this paper. IEC-61850 series consist of ten parts, and is a part of the working group TC57 reference

architecture [5]. It addresses the major concern of interoperability issue of IEDs/devices at bay level –a physical device connected to the network in a substation. The abstracted models of communication can be mapped into a number of already existing protocols, e.g. MMS, GOOSE, and soon the web services as well. The protocols may run over TCP/IP protocol stack, based on public as well as private networks, to ensure response times for certain services. The standard includes data modelling, reporting schemes, fast transfer of events, sampled data transfer, commands, storage and other relevant issues for this work.

On top of IEC-61850, we use Manufacturing Message Specification (MMS), which is an application layer protocol that defines rules, syntax, objects, structure of messages, and services to control, monitor, supervise devices [6]. It is an internationally accepted and widely adopted standard protocol, by industrial and manufacturing organizations that address interoperability issues of different vendor devices into smart grid. It thus provides benefits of flexibility of choosing devices from different manufacturers, reduced cost, product innovation, independency and interoperability [6] [7]. It is not concerned with how messages are traversed over the network and defines a local language translator, referred to as Virtual Manufacturing Device (VMD). VMD plays the role of a language translator which ensures correct understanding and delivery of messages among devices [6] [7].

MMS architecture follows a client-server model. Real industrial devices such as Integrated Electronic Devices (IEDs) act as MMS server, allowing MMS client to control, supervise and access the information from them. Therefore, ReGen plants, for instance wind power plants (WPP), have an IEC-61850 server (also called IED) that is controlled and monitored by a controller having an IEC-61850 client. Here, MMS client can be an application, HMI or SCADA machine at the control center. The IED represents all parameters of ReGen plants that are readable and/or writable by the client.

There is a number of challenges in controlling RES by remote controller (MVGC) such as latency, quality of service, scalability, reliability and security [8]. But this research focuses on network challenges, which are related to transportation of control messages over a communication network, such as latency, reliability, packet losses, network unavailability.

The remainder of this paper is organized as follows: Section-II provides the related work and brief introduction of the quality metric to be used. Section-III presents the scenario of the system adopted in this paper. Section-IV is related to the requirements of IEC 61850 MMS, and challenges of integrating it to support remote control communication for DER. It also covers the modeling and design of WPP production levels. Section-V provides the details of parameters used, and the implementation of IEC-61850 MMS model. It also explains the network topology and different parameters used in this paper. Section VI covers details of test execution and results. While Section-VII and Section-VIII finally present the conclusion, recommendations and suggestions for future

work.

## II. RELATED WORK

In this paper, the quality metric used to measure communication reliability, is based on the notion of the mismatch probability (mmPr) [9]. It is the probability that a certain information for processing by the controller does not match the value at a sensor in ReGen plant [10], defined in (1):

$$mmPr = Pr(I_{cc}(t_c) \neq I_{ct}(t_c)) \quad (1)$$

Here,  $I_{CC}$  and  $I_{CT}$  is the information available at the control-center and the controller respectively, while  $t_C$  is the control time where the two sets of information are compared. mmPr is not only recognized as a plausible quality metric for managing the dynamic subscriptions in the context management systems [10] [11], but is also used in the smart grid domain for finding an optimal waiting time of arriving at the DER, as well as their assignments to the aggregator control units [11] to control a set of DERs. This quality metric considers the network delay, information dynamics as well as the information access strategy in one single metric. Therefore, it makes it simple to analyze one single scaler value instead of several distributions in combination, for example, long delays and long event intervals compared with shorter delays and short event intervals versus update rates etc. Out of the three information access strategies (i.e. reactive access, proactive-periodic and proactive event-driven access) mentioned in [11], the reactive strategy (based on request-response strategy), is implemented in this work, because as mentioned in Section I, IEC-61850 MMS architecture follows a client-server model which is based on the request-response strategy.

## III. SCENARIO DESCRIPTION

Fig. 1 presents a microgrid scenario that comprises of a MV distribution system with three PVP plants (PVP1, PVP2, PVP3) and a WPP. A MV grid controller (MVGC), shown in Fig. 1, is responsible for ensuring that all control objectives are met. This MVGC, (could be a hardware control unit), can be placed locally in a primary substation or at the DSO control center. The scope of this research is to focus the communication between a single WPP and MVGC, as shown in Fig. 2. Thus, in order to implement demand-supply balance, the MVGC requires information about current energy production from WPP, and consequently direct it for any increase/decrease in the production. For this, MVGC periodically requests for the current state of energy production from WPP, which responds back accordingly. This is also known as a client-server communication model, as shown in Fig. 2, where MVGC being a client (requester), and WPP is a server. Since the objective of MVGC is to meet energy balancing goals, based on collected data, it takes control decision of increasing/decreasing power production level, by increasing the transition rate of state by some value (later referred to as  $\Delta$ ), so that it can push WPP in a desirable state of power production.

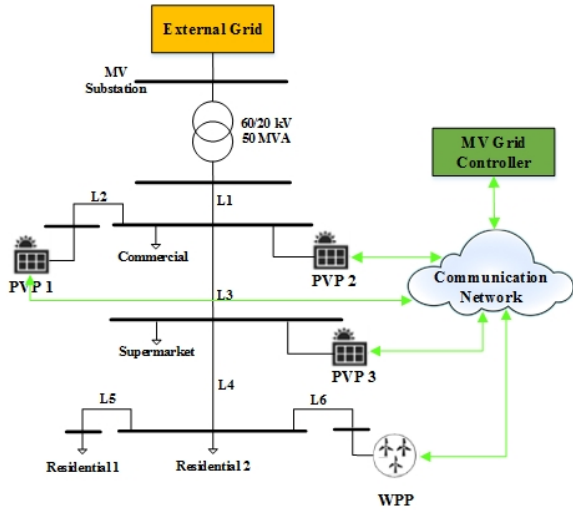

Fig. 1: Microgrid Scenario

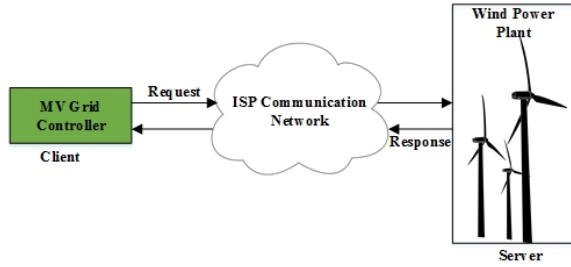

Fig. 2: Client-Server Communication in Microgrid

#### IV. INFORMATION MODELLING

Having described the scenario adopted in this paper, it is now necessary to model the required states of information of the current energy production generated by a ReGen plant. Since energy produced by WPP is a stochastic process, and can have multiple levels of production with time, Markov chain is one of the most commonly used tools for modeling such stochastic processes. Thus, it is assumed that a process of power production has finite number of states,  $S_1$  to  $S_M$ , as shown in Fig. 3. These states represent the amount of power generated by the WPP, for instance, state  $S_1$  represents the power generated from 0 to 1 kW, state  $S_2$  represents power generated from 1 to 2 kW, and so on. If WPP is in state 1, it jumps to state 2 with a transition rate of  $\lambda$ , and back from state 2 to 1 with a rate  $\mu$ . This applies for all states, as shown in Fig. 3.

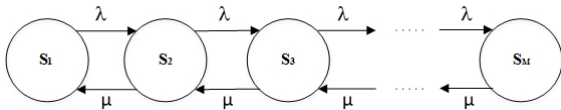

Fig. 3: Markov chain model of wind turbine energy production

The WPP is designed to send status updates periodically

to the MVGC through the communication network. In this model we do not consider the mechanical dynamics of the wind turbines, since events at instant speed lead to a change in production. However, due to the physical properties of a wind turbine this is not the case, as there will be some delay between the wind change and the change in output. Therefore, this model is better suited for PVPs though.

1) *IEC-61850 MMS Modelling*: IEC-61850 MMS was originally designed for OSI networking model, but since TCP/IP was never replaced by OSI [12], MMS is eventually mapped over the TCP/IP. For this, an interconnecting layer is used between TCP/IP T-profile and OSI A-profile layers [12]. This paper also models MMS over TCP/IP. Fig. 4 represents the protocol layers of MMS over TCP and UDP.

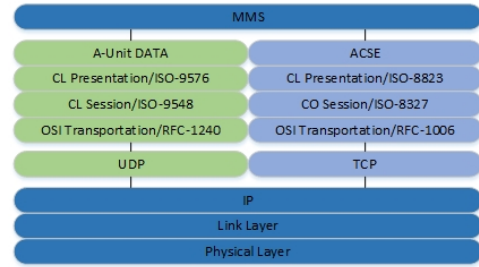

Fig. 4: The protocol layers of MMS over TCP and UDP [12]

Before sending MMS request by a client, it should establish an MMS association with MMS server. Further, it should establish a connection on the transport layer. In case of connectionless-mode, it does not require handshake at transport layer, and should make connectionless MMS association that simultaneously establishes and releases an association. Since the main focus of this paper is to analyze the impact of network delay, and packet losses on quality of MVGC performance and reliability of MMS server information, it has therefore been assumed that initial handshake in both layers (OSI and MMS) is already established. The area of study only focuses on main MMS request and response operation between MMS server and client.

2) *MMS Server Modelling*: As mentioned above, the process of power production of a WPP is modelled using a Markov birth/death chain, with the states representing the level of power generated by WPP. The Markov chain is mathematically described by the generator matrix  $Q$  with  $M$  finite states of the power generation, as in (2):

$$Q = \begin{bmatrix} -\lambda_{12} & \lambda_{12} & 0 & \dots & 0 \\ \lambda_{21} & -(\lambda_{21} + \lambda_{23}) & \lambda_{23} & 0 & \vdots \\ 0 & \lambda_{32} & -(\lambda_{32} + \lambda_{34}) & \lambda_{34} & \vdots \\ \vdots & \vdots & \ddots & \ddots & \vdots \\ 0 & 0 & \dots & \lambda_{M(M-1)} & -\lambda_{M(M-1)} \end{bmatrix} \quad (2)$$

Further, assuming that the system is at state  $i$ , the transition probability that the next state transition will be state  $j$ , calculated by (3), as:

$$P_{ij} = \frac{\lambda_{ij}}{\lambda_{ij} + \mu_{i-1}} \quad (3)$$

Practically, the MVGC (client) should have the ability to interrupt any state of WPP (server), so that the server can follow the controllers instruction immediately. However, in order to simplify our model, it is assumed that the system remains in each state, until its Mean Holding Time (MHT) expires. The MHT is defined as the time spent by system in a state, calculated in (4), as:

$$MHT = \frac{1}{\lambda + \mu} \quad (4)$$

At the beginning, ( $t = 0$ ), the initial probability is  $P_o = [1, 0, 0, 0, 0, 0]$ . It is the probability that system is in state  $S_1$  at  $t = 0$  and remains in the same state until its MHT expires. The WPP then jumps to state  $S_2$  and remains in the same state until the MHT expires. It keeps on jumping to different states, back or forth, decided by a random number generator. If the random number is greater than the probability of moving forward, the system jumps forward, if not, it jummps to the previous state.

3) *MMS Client Modelling*: MVGC acts as an MMS client and it is responsible of controlling the power production of WPP. Thus, it has been designed such that it speeds up/down the process of power production, to keep the output power level in the desired state/s. Here, it is assumed that states  $S_3$  and  $S_4$  are the desired states. Now, in order to represent the control actions carried out by MVGC, to get to the desired state under the influence of some random events, we use  $\Delta$  to simplify our model. For instance, if WPP is in a state below  $S_3$ , the MVGC sends a control signal to increase the transition rate with a value of  $\Delta$ , as shown in Fig. 5(a). Similarly, if WPP is in any state above  $S_4$ , it increases the transition rate in backward direction with same value of  $\Delta$ , as shown in Fig. 5(b).

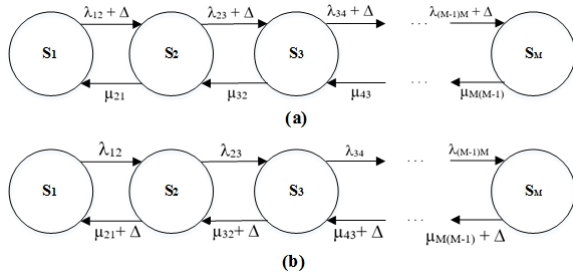

Fig. 5: State transition diagram with (a) rate  $\lambda + \Delta$  in forward direction (b) rate  $\mu + \Delta$  in backward direction

4) *Defining the Quality of Controller*: One of the objectives of this paper, is to evaluate the quality of the controller performance for different network conditions. Since the function of controller is to keep WPP in a desirable state, the quality of the controller performance is measured using (5), as:

$$QoC = \frac{\pi_i}{T_{total}} \quad (5)$$

Here, QoC is the quality of the controller performance,  $\pi_i$  is the steady state probability of being in state  $i$ , and  $T_{total}$  is the total time used to observe the system. It has been assumed that the desirable states of the server are  $S_3$  and  $S_4$ , therefore QoC is given by (6) as:

$$QoC = \frac{\pi_3}{T_{total}} + \frac{\pi_4}{T_{total}} \quad (6)$$

Here,  $\pi_3$  and  $\pi_4$  denote the steady state probability of being in state  $S_3$  and  $S_4$ , respectively.

## V. NETWORK PARAMETERS AND TOPOLOGY

The performance assessment cases are classified into three groups based on the network performance parameters of packet delays, transport layer connection lost, and packet losses as follows:

*Case 1: Network Delay*: Assess mmPr and controller performance of MMS model over TCP and UDP for different packet delays

*Case 2: Network Unavailability*: Assess mmPr and controller performance of MMS model over TCP and UDP in case of network unavailability

*Case 3: Network Link Error*: Assess mmPr and controller performance of MMS model over TCP and UDP for packet losses

MMS traffic was generated over TCP and UDP as an underlying protocol, using NS3 as a network simulation tool. The traffic was sent between MVGC and WPP, and all test cases were executed for different network conditions. The tests were performed by generating 10,000 MMS requests both for TCP and UDP, with a request rate of 1 packet per second (i.e. a total of 10,000 sec.). The trace files collected for both transport layer protocols were then analyzed using MATLAB, in order to understand the impact of network performance parameters, i.e. data reliability in terms of mmPr, quality of controller performance and performance of MMS communication over TCP and UDP.

1) *Simulation Parameters*: The scenario and MMS server-client model considered for this paper has several parameters. Different values of these parameters can lead to multiple test cases and diversity in the research work. To be left as future work, values of different parameters are assumed to be constant. Table 1 lists the parameters and their respective values considered in this paper.

State transition rate in forward and backward directions are represented by  $\lambda$  and  $\mu$ , respectively. Here,  $\lambda$  and  $\mu$  are exponentially distributed random variables with a mean value of 1. The mean value of exponentially distributed random variables represents the mean waiting time to enter into another state. It has been selected to be 1, so that the state of WPP can be analyzed every second. Moreover, for the purpose of modelling WPP energy production as a continuous Markov

TABLE I: List of Parameters and their values

Parameter	Description	Value
$\lambda$	State transition rate in forward direction	$\lambda_{12}=0.63, \lambda_{23}=0.3, \lambda_{34}=0.02, \lambda_{45}=0.01, \lambda_{56}=0.91$
$\mu$	State transition rate in backward direction	$\mu_{65}=0.21, \mu_{54}=0.36, \mu_{43}=0.11, \mu_{32}=0.97, \mu_{21}=0.43$
Request Rate	MMS client request rate to query about server state	1
$\Delta$	Drift rate to increase state transition rate in forward/backward direction	0.5
Desirable State	Desirable state from controller perspective	3 and 4

random process, all the values of  $\lambda$  and  $\mu$  are kept different, to model the fluctuations and variations in wind speed.

Upon intervention of the controller, the state transition rate will drift up with constant rate of  $\Delta$ . Here,  $\Delta$  is used to increase the transition rate, so that WPP (server) can reach the desirable state rapidly. To find an optimum value of  $\Delta$  is an additional research problem. It could be kept varying between 0 to 1, in order to find its optimal value for our model. However, for this paper a mid-point value of 0.5 has been selected.

2) *Network Topology*: IEC-61850 supports flexibility of choosing different communication networks for example 3G, 4G, LTE and WiMAX etc. However, the goal in this work is to evaluate the network performance using IEC-61850 MMS remote control communication. In order to achieve this goal, an Ethernet based Internet Service Provider (ISP) cloud has been used as a communication medium, with a channel bandwidth of 10 Mbps for MMS communication between MVGC and WPP. For now, it has been assumed to be a non-shared medium.

## VI. RESULTS AND DISCUSSION

1) *Case 1: Network Delay*: Packet delays of different values were used in this case, so that the results can be mapped on network delays (latency) of different communication technologies (e.g. DSL, LTE and WiMAX). With different delay values, 10,000 MMS request packets were sent from the MMS client to the MMS server through the communication medium, with 0% packet losses for a period 10,000 seconds. This means, an MMS request is sent from client to server every second, to perform control action based on received information.

Fig. 6 shows the assessment of mmPr for MMS model over TCP and UDP based on network delays as well as the quality of controller performance for the same case. It has been observed from Fig. 6 that, for communication over TCP and UDP, the mmPr increases with latency. The reason for this is that when the response message arrives with higher delay, there are higher chances that the current state of server may have jumped to the next state, causing a mismatch of

information. On the other hand, it can also be seen that the impact of latency on data reliability remains the same for MMS over TCP and UDP. This is quite an expected result, because under normal conditions of network, TCP and UDP show the same performance. TCP only differs in that it requires two 3-way handshakes, i.e. one on the transport layer, and another on application layer for MMS, before starting MMS data exchange [8].

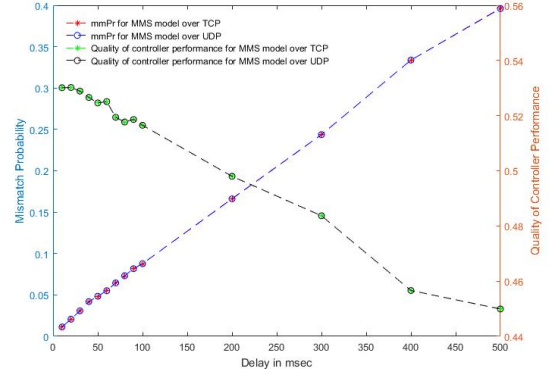

Fig. 6: Assessment of mmPr for different network delays

Before discussing the results of quality of controller performance, it is necessary to mention that this performance has been calculated using (6), defined in Section IV. However, it cannot be analyzed independently, because it highly depends upon the amount of time the server (WPP) spends in the desirable states. As described in Section IV, the server remains in each state until its MHT expires, even in the absence of controller. Therefore, it is necessary to calculate the percentage of time, during which the server stays in state  $S_3$  and  $S_4$ , when there is no control from MMS client (controller).

Considering up to 10 states of the server, it has been recorded that around 30% to 40% of the total time server remains in states  $S_3$  and  $S_4$ . Based on this baseline for the controller performance, it can be observed from Fig. 6 that the controller performance is 53% in start. However, the delay in response may lead to mismatch of information, leading to wrong control actions. Thus, the controller quality degrades to 45% approximately. Furthermore, test results show that behavior of the controller performance remains the same for TCP and UDP, because of their same behavior.

2) *Case 2: Network unavailability*: This case was carried out to evaluate the impact of network unavailability which, causes a connection lost at the transport layer. Different connection lost time durations were used to analyze the results. However, a connection loss for only 10 seconds time duration is shown here. Additionally, connection is lost after every 2000 seconds, thus, the number of connections lost, is counted to be 5 in a total time of 10,000 seconds. As in case 1, this case was also performed with different latencies, using 0% packet losses, so that the test results can be compared with the results of case 1.



The results in Fig. 7 show that there is no such impact of connection lost for 10 seconds duration on mmPr, even for TCP, because 10 seconds of connection lost is considered as if the controller was absent for 10 seconds. In case of no controller, there is no request from controller, and ultimately no chance of mismatch of information.

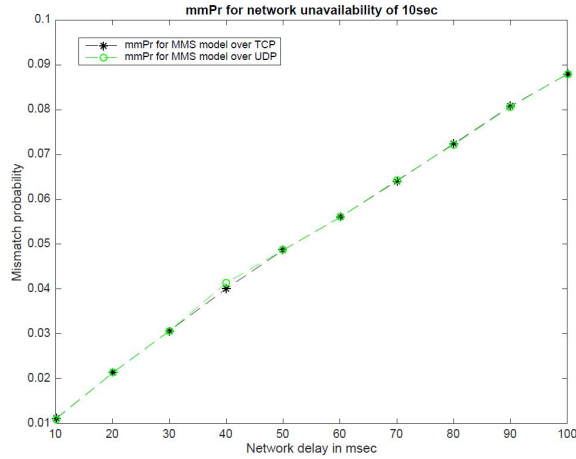

Fig. 7: mmPr with network unavailability of 10 Sec. for 5 times

It can be observed from Fig. 8 that the controller performance is not effected much by such a short duration of network unavailability of 10 seconds, compared to the total duration of 10,000 seconds. Thus, as soon as the network becomes available, the controller starts working normally. However, the assumption that the controller cannot interrupt the server, if it jumps into a new state until its MHT, has a major impact on controller's performance. This however, can be improved if the controller is given full charge of interrupting the WPP's states at any time. Furthermore, the controller performance for TCP and UDP is observed to be the same for different network delays with no packet losses.

3) *Test Case 3: Network Link Error*: In order to evaluate the impact of packet loss on the MMS model, a range of network error rates were introduced in the network, ranging from 0.001 to 0.05. The idea is to understand the behavior of the MMS model running over UDP and TCP. The loss of packets with UDP would cause a loss of a client request, or loss of server response. Whereas for TCP, the communication is connection-oriented, where a lost packet is retransmitted. Presumably, it can be ascertained that the more errors, the higher the packet losses will be, effecting the mismatch probability and ultimately the controller performance. This however, is tested using the IEC-61850 MMS model designed in this paper.

Fig. 9 shows that increase in packet losses causes increase in mmPr both for UDP and TCP. In case of TCP, each time a packet is lost, it is retransmitted causing delay in the request/response packet. The retransmitted response packet carrying the information from the server, may become outdated for the controller, causing mismatch of server state

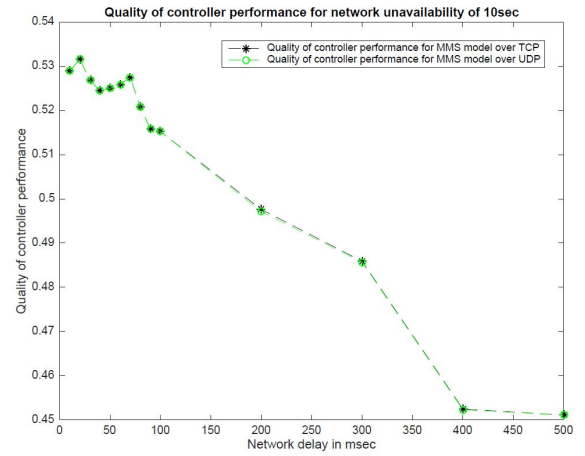

Fig. 8: Quality of controller performance with 5 TCP connection losses for 10 Sec.

information. However, in case of UDP, packet losses have no significant impact on mmPr. If any request/response packet is lost during transmission, the next request message can recompense the job of getting latest information, as observed in Fig. 10. It is also important to note that, percentage of packet losses is higher for TCP than UDP, simply because TCP has a larger number of packets for request/responses, due to the acknowledgement mechanism.

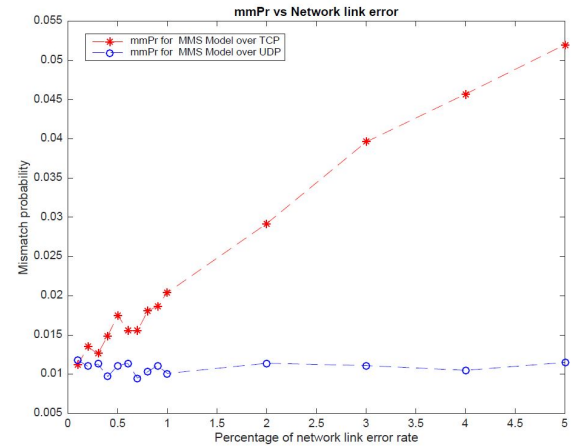

Fig. 9: mmPr for different network link errors

For the quality of controller performance, in case of TCP, it can be observed from Fig. 10 that there is a trade-off between packet losses and performance of controller. As packets are lost in the network, the controller is not able to make timely control actions, degrading the controllers performance quality, as shown in Fig. 10.

## CONCLUSION AND FUTURE WORK

In this paper, a simulation based model for IEC-61850 MMS has been established, in order to provide an experimental study for assessing reliable power balancing in the MV microgrid,

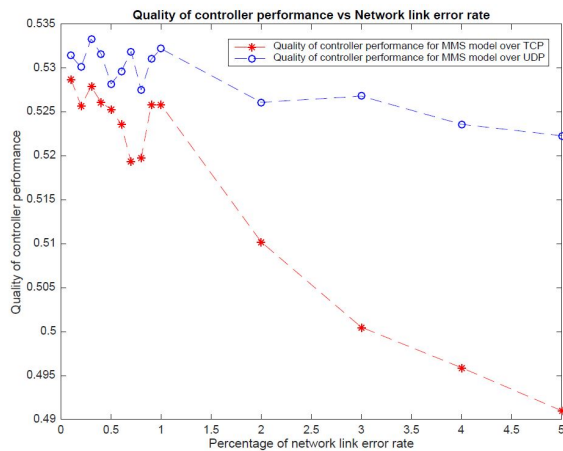

Fig. 10: Quality of controller performance for different link errors

over different communication technologies, to compensate imbalance between demand and response. This research work introduces a way to measure quality of controller performance, in the interest of balancing energy generation and consumption. One of the focal point in this paper is to understand the behavior of mmPr with the injection of MMS traffic over TCP and UDP across simulated ISP network cloud. ISP cloud provided with different network delays, has significant impact on mmPr, which enables to conclude that increase in network delay increases the mmPr.

The results revealed that under normal conditions with zero packet loss and network unavailability conditions, mmPr for MMS model over TCP and UDP gives almost the same results. The slight difference is noticed because TCP requires additional steps of transport layer and MMS association handshakes in comparison to UDP. Theoretically, there's always a tradeoff between quality of controller performance and mmPr, network delay and unavailability, which can be observed from the results. However, the quality of controller performance is also dependent upon the design of a particular controller.

It was also observed that packet loss has heavy impact on MMS model for TCP as compare to UDP. mmPr for TCP is higher than UDP mmPr. On the other hand, retransmission of lost packets in TCP brings no good for controller performance. While, in UDP, packet loss has not affected the controller performance much with a request rate of 1 second. However, if the request rate is reduced, controller performance may also have effected in case of UDP. For the designed IEC-61850 MMS model, TCP and UDP have no dominance over each other under different network delays. While in case of network unavailability, each time the network is restored, TCP requires extra steps for handshaking in comparison to UDP. However, with increasing packet rates, our studies indicate that UDP performs better than TCP.

There are several simulation parameters involved in this work, as mentioned in Section IV, which can be varied

to make the system more realistic, near to real scenario. The model designed for energy production from WPP can be extended in different ways, for instance, incorporate the ON/OFF state of wind turbine along with finite/infinite states of energy production levels. Similarly, the MVGC's function can be extended to be more interactive by taking the input from relevant stakeholders who take care of energy demand and supply. In future, more test cases will be executed to analyze the use of TCP/UDP in a smart grid scenario based on mmPr and controller quality as a function of varying request rate, as well as a function of varying cross traffic. Finally, the performance of TCP and UDP based on mmPr will be analyzed on specific communication technologies e.g. WiMAX, LTE and WiFi etc. in an HIL environment.

#### ACKNOWLEDGMENT

Energinet.dk is acknowledged for funding this work in contract number: PSO project 2015 no. 12347, Ancillary Services from Renewable Power Plants (RePlan), [www.replanproject.dk](http://www.replanproject.dk)

#### REFERENCES

- [1] R. Zamora and A. K. Srivastava, "Controls for microgrids with storage: Review, challenges, and research needs," *Renewable and Sustainable Energy Reviews*, vol. 14, no. 7, pp. 2009 – 2018, 2010.
- [2] P. Sorkns, H. Mng, T. Weiss, and A. N. Andersen, "Overview of the danish power system and res integration," Tech. Rep., 2013.
- [3] *Communication Architecture of the IEC 61850-based Micro Grid System*, September 2011.
- [4] G. Dondossola, R. Terruggia, S. Bessler, J. Grnbk, P. Zwickl, R. L. Olsen, F. Iov, C. Haegerling, F. Kurtz, D. Iacono, A. Bovenzi, S. Marzorati, and A. Carrapatoso, "Smartc2net use cases - preliminary architecture and business drivers," Tech. Rep., 2014.
- [5] "Iec - tc 57, power systems management and associated information exchange." [Online]. Available: [http://www.iec.ch/dyn/www/f?p=103:7:0:::FSP\\_ORG\\_ID,FSP\\_LANG\\_ID:1273,25](http://www.iec.ch/dyn/www/f?p=103:7:0:::FSP_ORG_ID,FSP_LANG_ID:1273,25)
- [6] D.-I. K. Schwarz, "Manufacturing message specification - iso 9506 (mms)," Tech. Rep. [Online]. Available: [http://www.nettedautomation.com/download/mms-r1-2\\_2008-02-26.pdf](http://www.nettedautomation.com/download/mms-r1-2_2008-02-26.pdf)
- [7] M. S. Thomas, I. Ali, and N. Gupta, "Interoperable framework for iec61850-compliant ieds and noncompliant energy meters with scada," *Energy Technology & Policy*, vol. 2, no. 1, pp. 73–81, 2015. [Online]. Available: <http://dx.doi.org/10.1080/23317000.2015.1022841>
- [8] G. T. Pham, "Integration of iec 61850 mms and Ite to support smart metering communications," August 2013. [Online]. Available: <http://essay.utwente.nl/64424/>
- [9] R. L. Olsen, H. P. Schwefel, and M. B. Hansen, "Quantitative analysis of access strategies to remote information in network services," in *IEEE Globecom 2006*, Nov 2006, pp. 1–6.
- [10] M. Findrik, J. Groenbaek, and R. L. Olsen, "Scheduling data access in smart grid networks utilizing context information," in *2014 IEEE International Conference on Smart Grid Communications (SmartGridComm)*, Nov 2014, pp. 302–307.
- [11] A. Shawky, R. Olsen, J. Pedersen, and H. Schwefel, "Network aware dynamic context subscription management," *Computer Networks*, vol. 58, 2014.
- [12] S. Feuerhahn, R. Kohrs, and C. Wittwer, "Remote control of distributed energy resources using iec-61850 as application-layer protocol standard," *Energy Technology*, vol. 2, no. 1, pp. 77–82, 2014.